

Data Sheet



Article number: 0121055

Description: Retaining ring JL 38X1,5
Spring steel

Measures

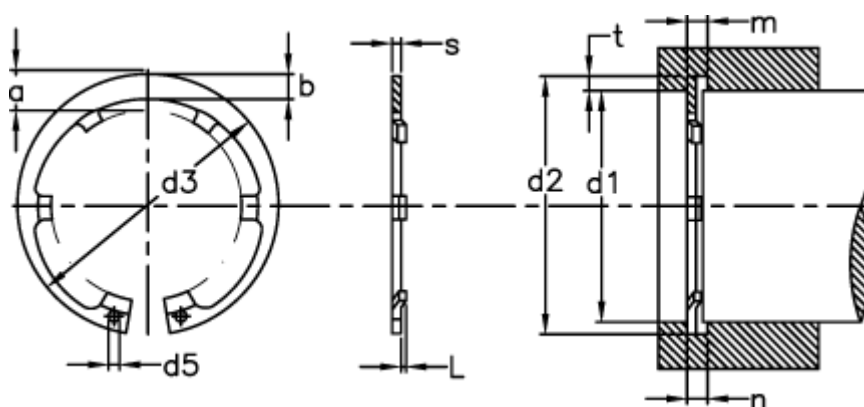

a max	= 6.1	FL max kN	= 0.73	s	= 1.50
b	= 3.8	FN kN	= 22.5	tol	= 0.25
C kN/mm	= 2.07	FRg kN	= 6.70	tol	= +0,50 -0,25
d1	= 38	FR kN	= 28.20	u	= 0.10
d2	= 40.0	g	= 1.5		
d3	= 40.8	L min	= 0.45		
d5 min	= 2.5	m min	= 1.60		
Description	= AL 38	Nominal drive	= 3.0		